

SECTION. A-A

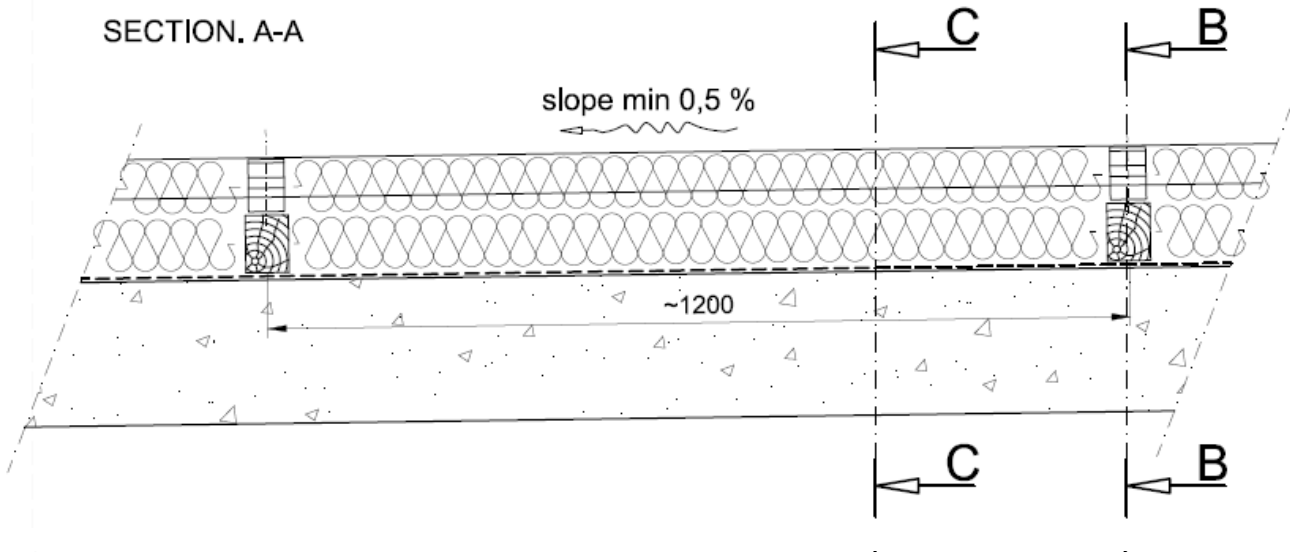

SECTION. B-B

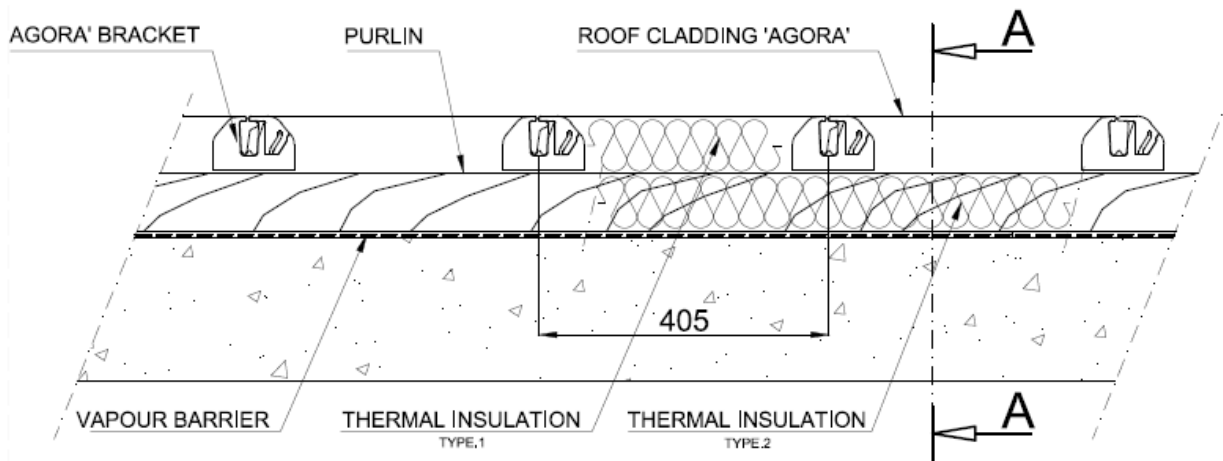

SECTION. C-C

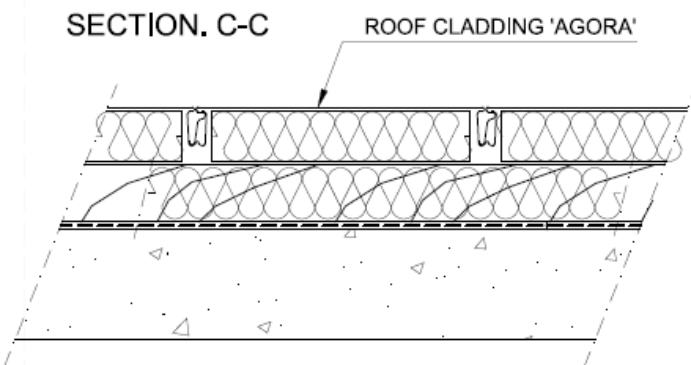

SECTION. C-C  
(with timber shuttering)

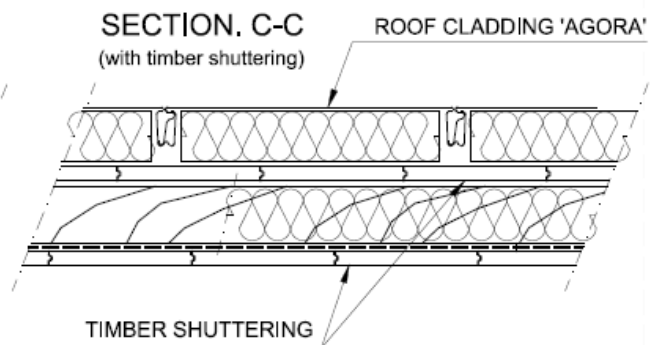

LONGITUDINAL SECTION

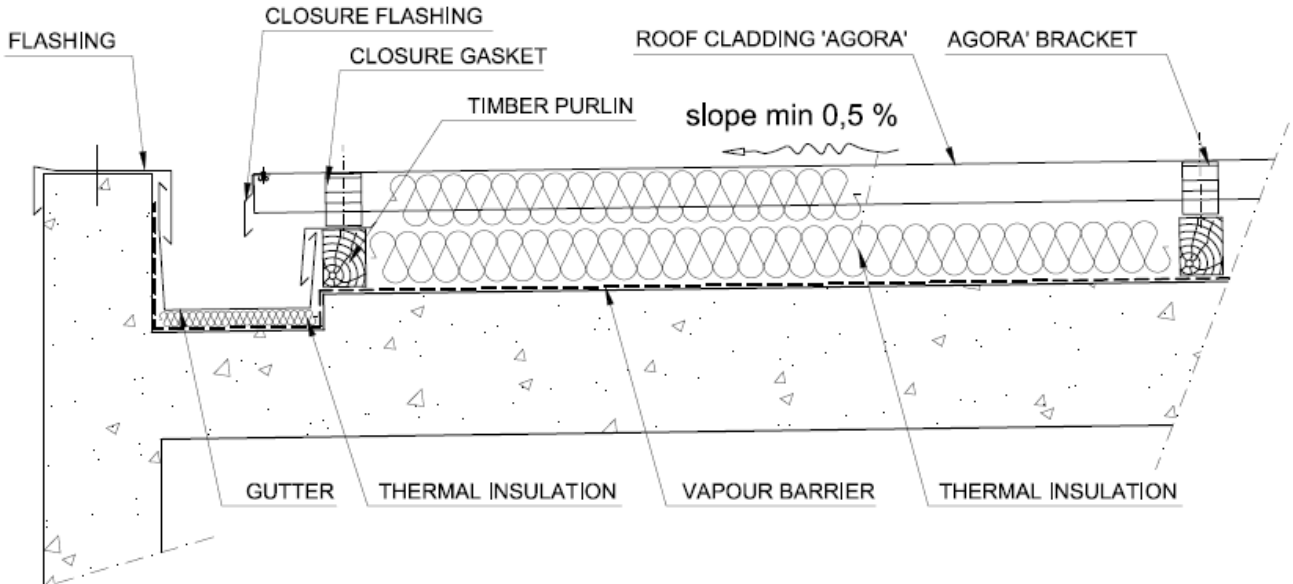

SECTION. A-A

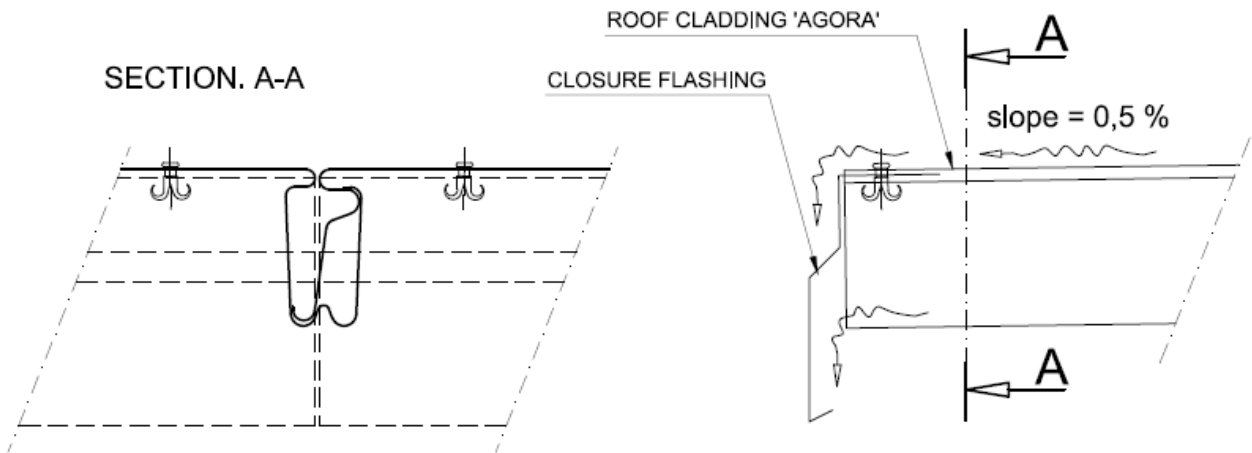

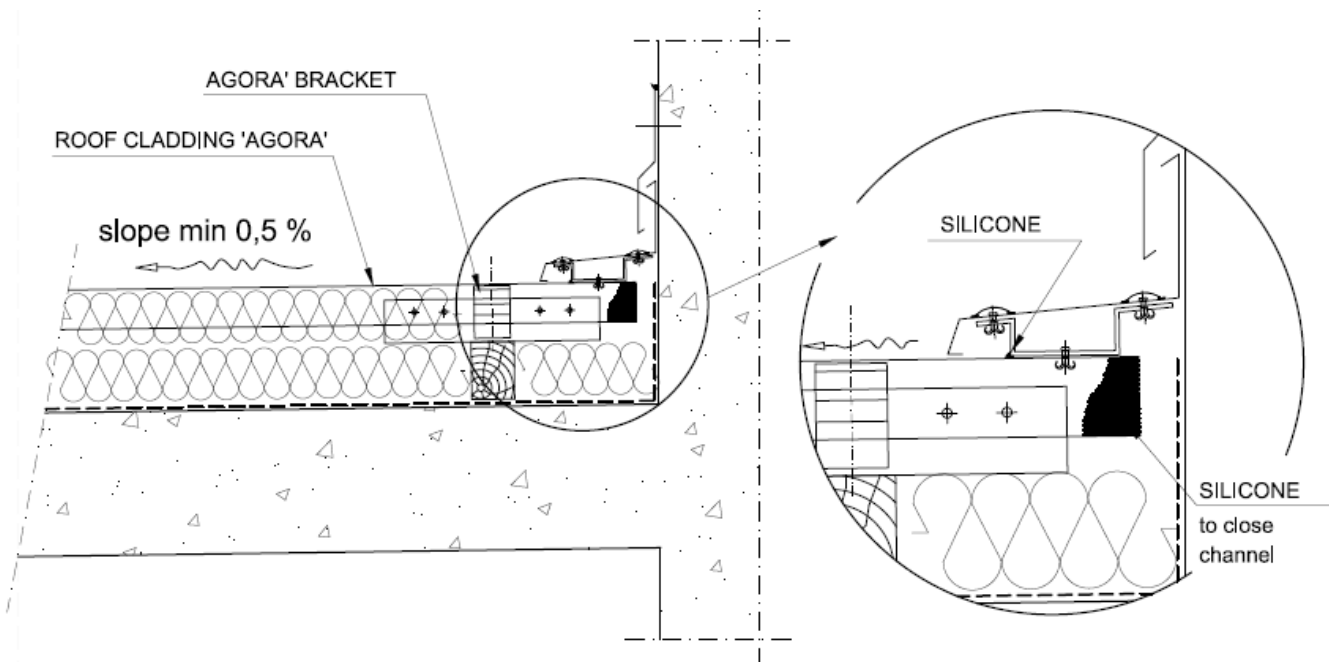
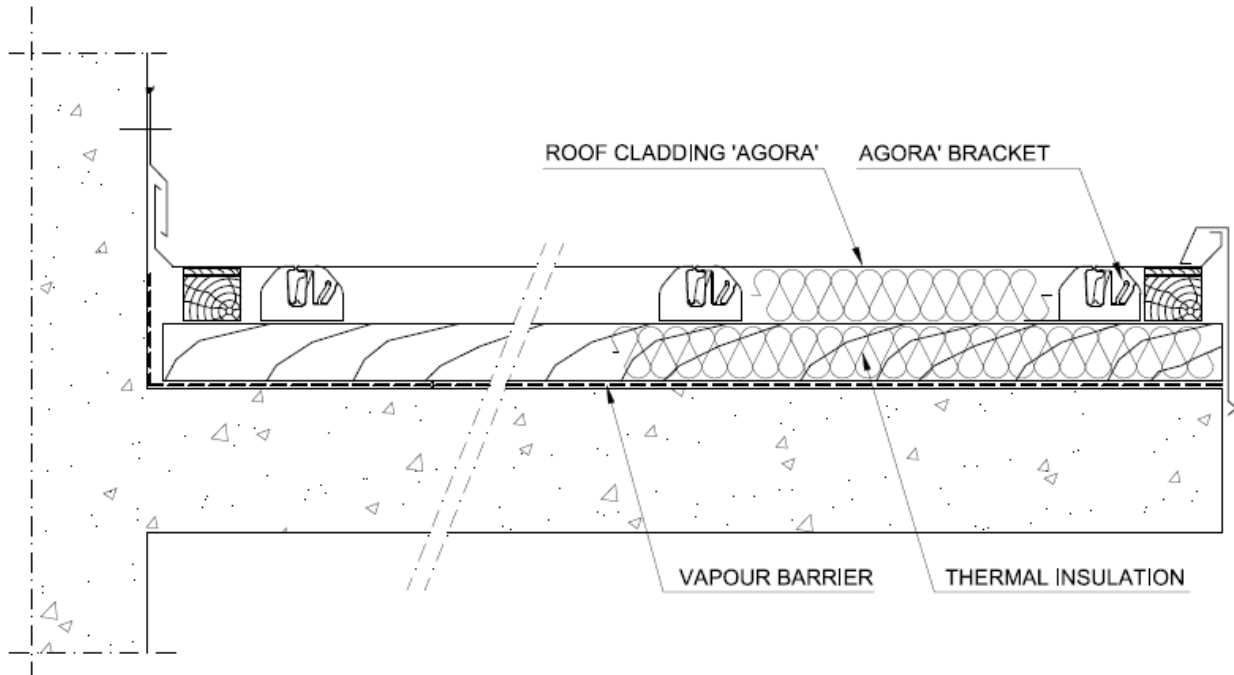

---

FACADE APPLICATION

---

